

Flat Wall Signs

FLAT-WP Series

A range of flat wall mountable sign frames available in both portrait and landscape orientations. Featuring a high quality extruded aluminum body with plastic molded end caps. Custom sizes are offered to meet your specifications.



FINISH:



Silver



Black

PROFILE:



Round



Square

features and benefits:

- High quality flat aluminum body available in anodized silver or powder-coated black finish
- Choice of black or gray plastic end caps
- Option of round or square profile
- Comes standard with non-glare lens, unless otherwise specified
- Double sided adhesive tape included, holes for screw mount at additional cost
- Custom sizes available

dimensions:

Hardware

Assembled unit:

- Custom sizes available
- All lengths measurements (as shown on following page) apply to the extrusion only and exclude the end caps

Shipping

Shipping weights and dimensions vary depending on the quantity of product ordered. Contact your dealer for your specific weights and dimensions.

additional information:

Graphic material:

Frames can accommodate a multitude of sign substrates from printed paper inserts, laminated printed, cut vinyl, etc. Your sign professional will help you find the material that's right for your project.

SIGNPRO™
S Y S T E M S

We are continually improving and modifying our product range and reserve the right to vary the specifications without prior notice. All dimensions and weights quoted are approximate and we accept no responsibility for variance. E&OE. See Graphic Templates for graphic bleed specifications.

■ Frame Size ◆ Graphic Dims ● Visible Area

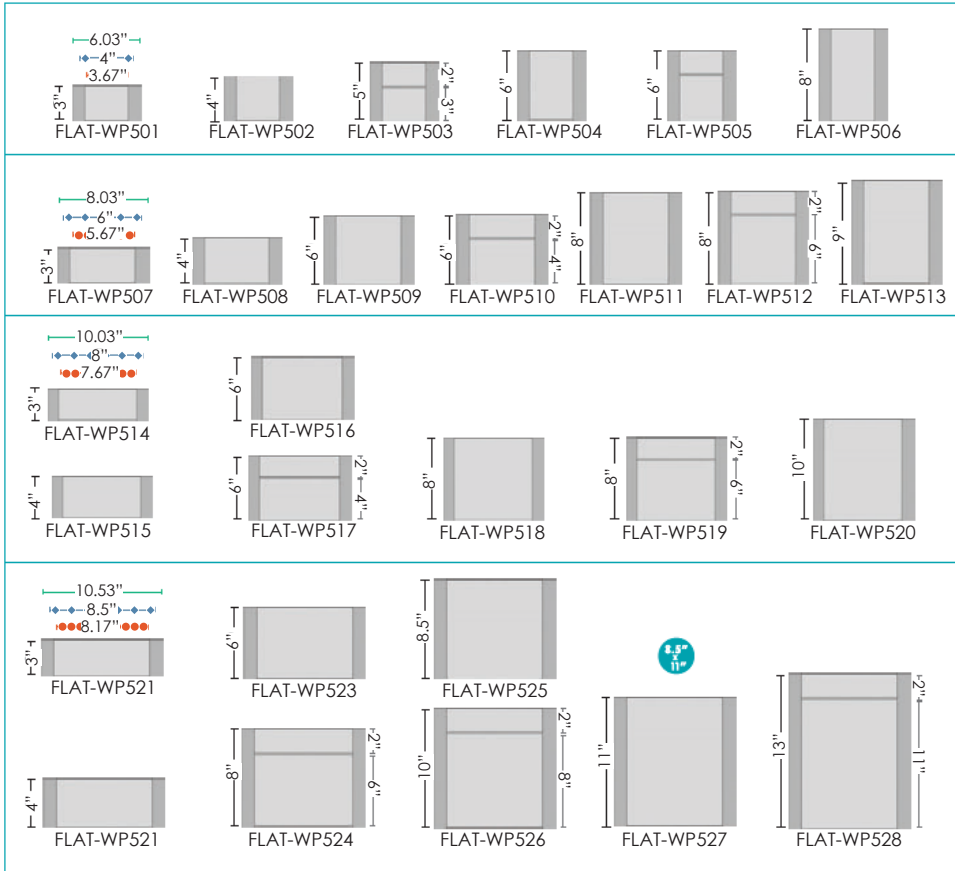

4

6

8

8.5



11

12

17

■ Frame Size ◆ Graphic Dims ● Visible Area

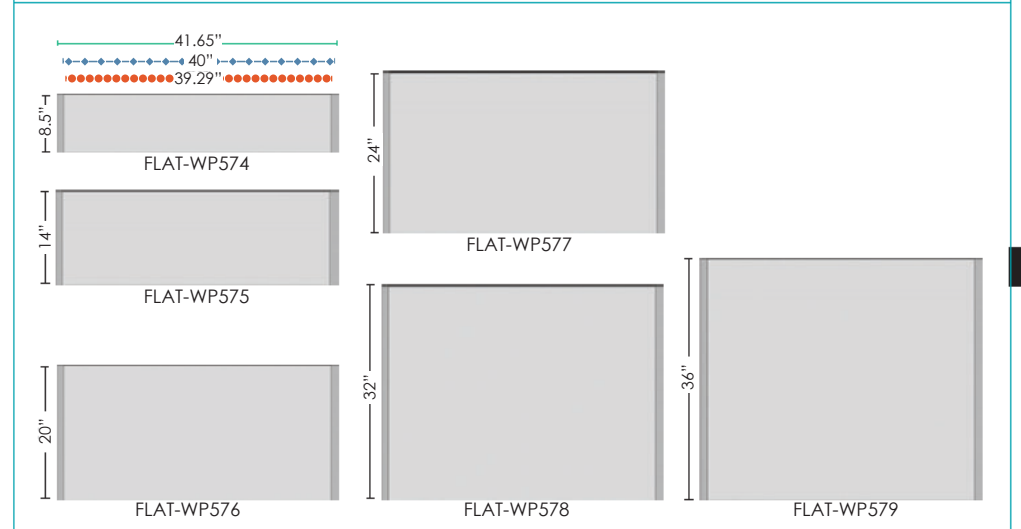
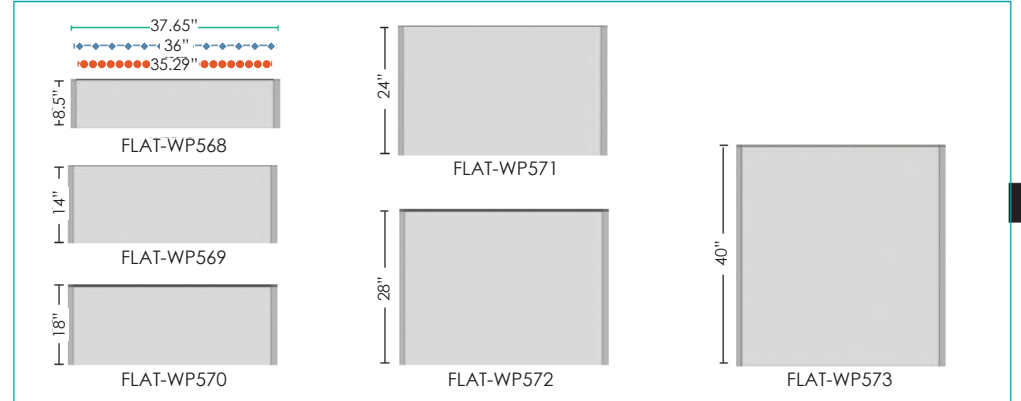
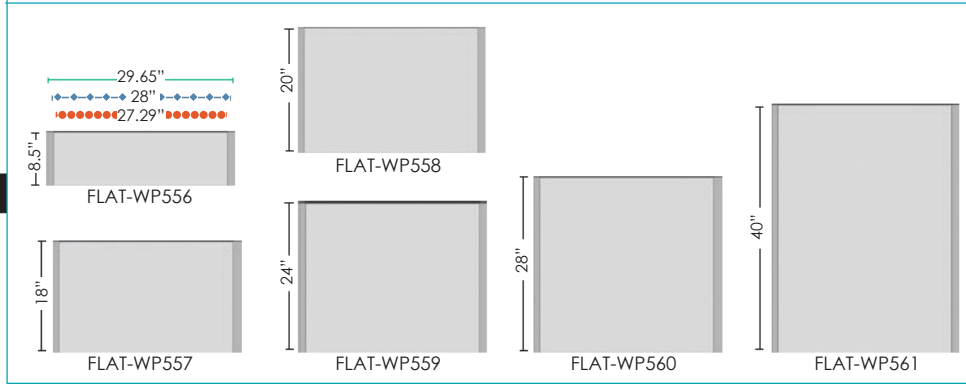
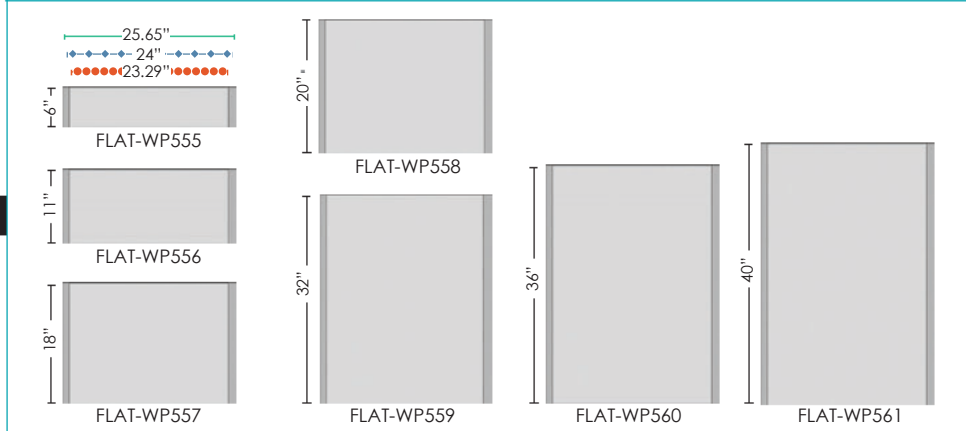
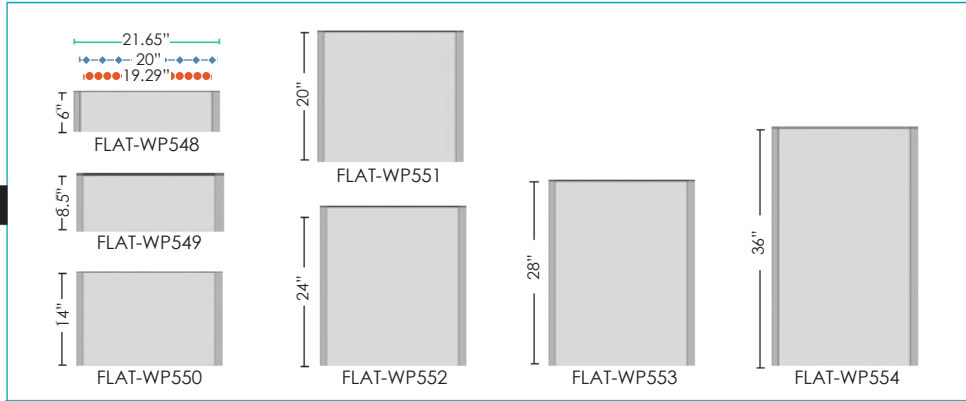

20

24

28

36

40

Mounting Instructions

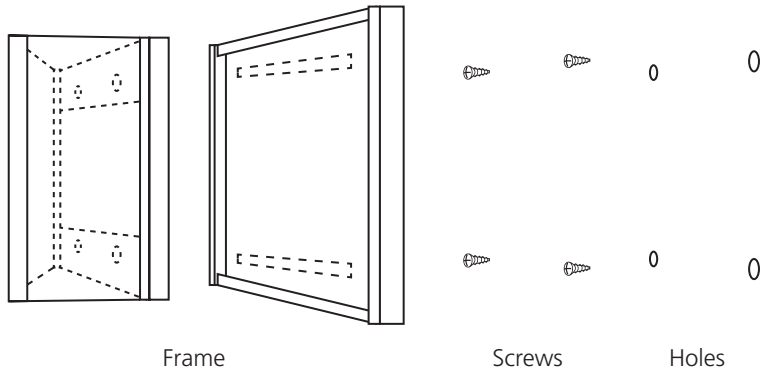

Frame

Screws

Holes

Direct to Wall

FLAT-WP
FLAT-PJT
FLAT-DIRP
FLAT-DIRM

- Step 1.** Set frame on wall in desired location.
- Step 2.** Mark holes, remove frame, and drill holes.
- Step 3.** Place anchors in drilled holes, screws in anchors, then screw into wall.
- Step 4.** Mount frame by lining channel bars with screws.

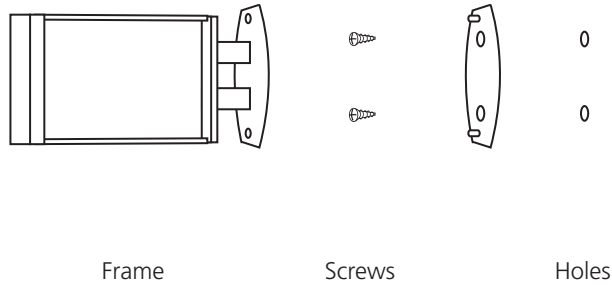

Frame

Screws

Holes

Bracket to Wall

FLAT-PJL
FLAT-PJP

- Step 1.** Set bracket on wall in desired location.
- Step 2.** Mark holes, remove bracket, and drill holes.
- Step 3.** Place anchors in drilled holes, then return bracket to wall.
- Step 4.** Place screws through bracket face and screw into anchors.
- Step 5.** Apply nut caps.

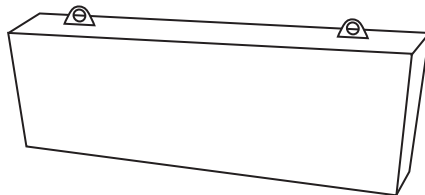

Suspend

FLAT-SUSP

- Step 1.** Install mounts (not included) on ceiling in desired location.
- Step 2.** Attach cables (not included) to mounts and frame rings.

Mounting Tape

- Step 1.** Remove paper cover from tape.
- Step 2.** Apply frame to wall in desired location.