

# Flat Suspended Signs

## FLAT-SUSP Series

The FLAT-SUSP Series combines sets of back-to-back extrusion for elegant, effective signage and comes in a variety of standard formats. Available in anodized silver or powder-coated black finish. Clear, non-glare lenses are optional and custom sizes are offered to meet your specifications.



## features and benefits:

- Double-sided landscape frames
- Available in anodized silver or black
- Option of round or square profile
- Choice of black or grey end caps
- Standard with clear non-glare lens and suction cup for quick, graphic changes-  
No assembly required
- Custom sizes available
- Quick shipping

## dimensions:

### Hardware

### Assembled unit:

- Custom sizes available
- All lengths measurements (as shown on following page) apply to the extrusion only and exclude the end caps

### Shipping

Shipping weights and dimensions vary depending on the quantity of product ordered. Contact your dealer for your specific weights and dimensions.

## additional information:

### Graphic material:

Frames can accommodate a multitude of sign substrates from printed paper inserts, laminated printed, cut vinyl, etc. Your sign professional will help you find the material that's right for your project.

**SIGNPRO™**  
S Y S T E M S

We are continually improving and modifying our product range and reserve the right to vary the specifications without prior notice. All dimensions and weights quoted are approximate and we accept no responsibility for variance. E&OE. See Graphic Templates for graphic bleed specifications.

■ Frame Size ◆ Graphic Dims ● Visible Area

4

6.03"  
4"  
3.67"



FLAT-SUSP501

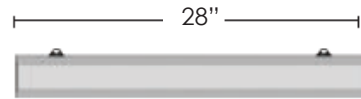

FLAT-SUSP502

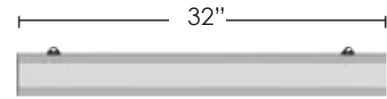

FLAT-SUSP503

6

8.03"  
6"  
5.67"

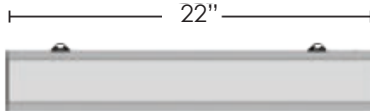

FLAT-SUSP504

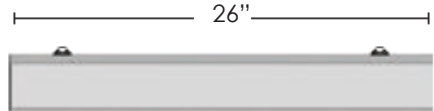

FLAT-SUSP505

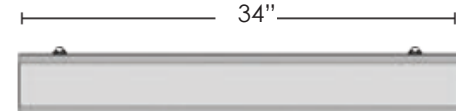

FLAT-SUSP506

8

10.03"  
8"  
7.67"



FLAT-SUSP507

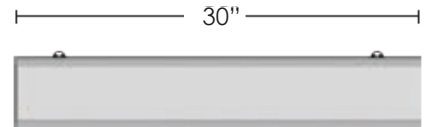

FLAT-SUSP508



FLAT-SUSP509

LETTER

10.53"  
8.5"  
8.17"



FLAT-SUSP510

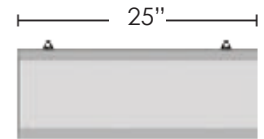

FLAT-SUSP511

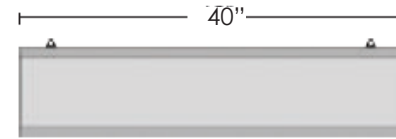

FLAT-SUSP512

11

13.03"  
11"  
10.67"

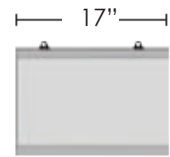

FLAT-SUSP513

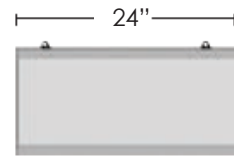

FLAT-SUSP514

17

19.03"  
17"  
16.67"



FLAT-SUSP515

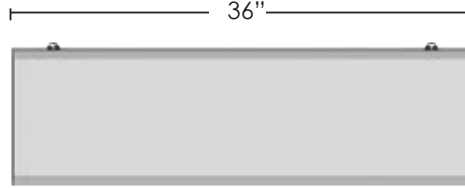

FLAT-SUSP516

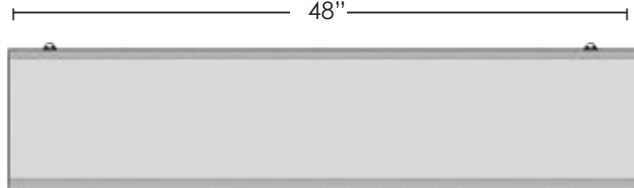

FLAT-SUSP517

# Mounting Instructions

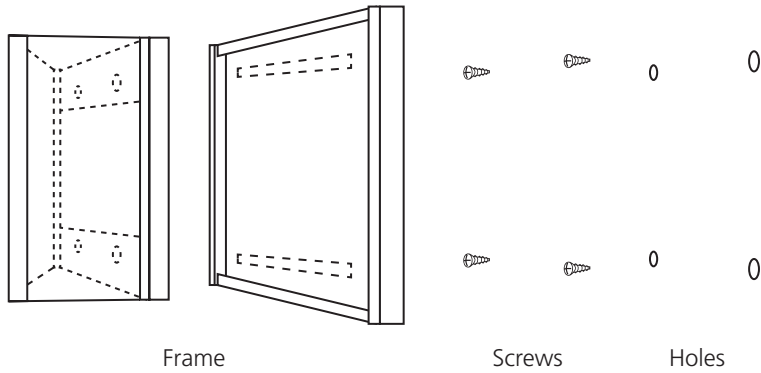

Frame

Screws

Holes

## Direct to Wall

**FLAT-WP**  
**FLAT-PJT**  
**FLAT-DIRP**  
**FLAT-DIRM**

- Step 1.** Set frame on wall in desired location.
- Step 2.** Mark holes, remove frame, and drill holes.
- Step 3.** Place anchors in drilled holes, screws in anchors, then screw into wall.
- Step 4.** Mount frame by lining channel bars with screws.

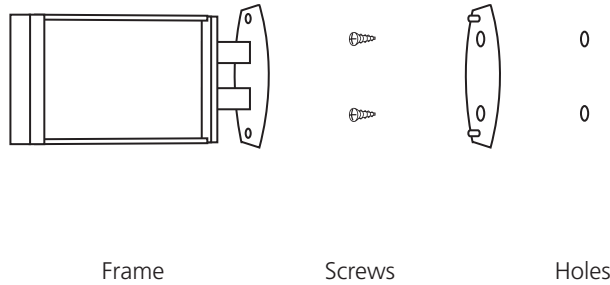

Frame

Screws

Holes

## Bracket to Wall

**FLAT-PJL**  
**FLAT-PJP**

- Step 1.** Set bracket on wall in desired location.
- Step 2.** Mark holes, remove bracket, and drill holes.
- Step 3.** Place anchors in drilled holes, then return bracket to wall.
- Step 4.** Place screws through bracket face and screw into anchors.
- Step 5.** Apply nut caps.

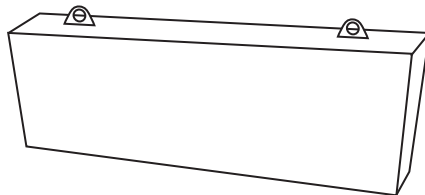

## Suspend

**FLAT-SUSP**

- Step 1.** Install mounts (not included) on ceiling in desired location.
- Step 2.** Attach cables (not included) to mounts and frame rings.

## Mounting Tape

- Step 1.** Remove paper cover from tape.
- Step 2.** Apply frame to wall in desired location.